

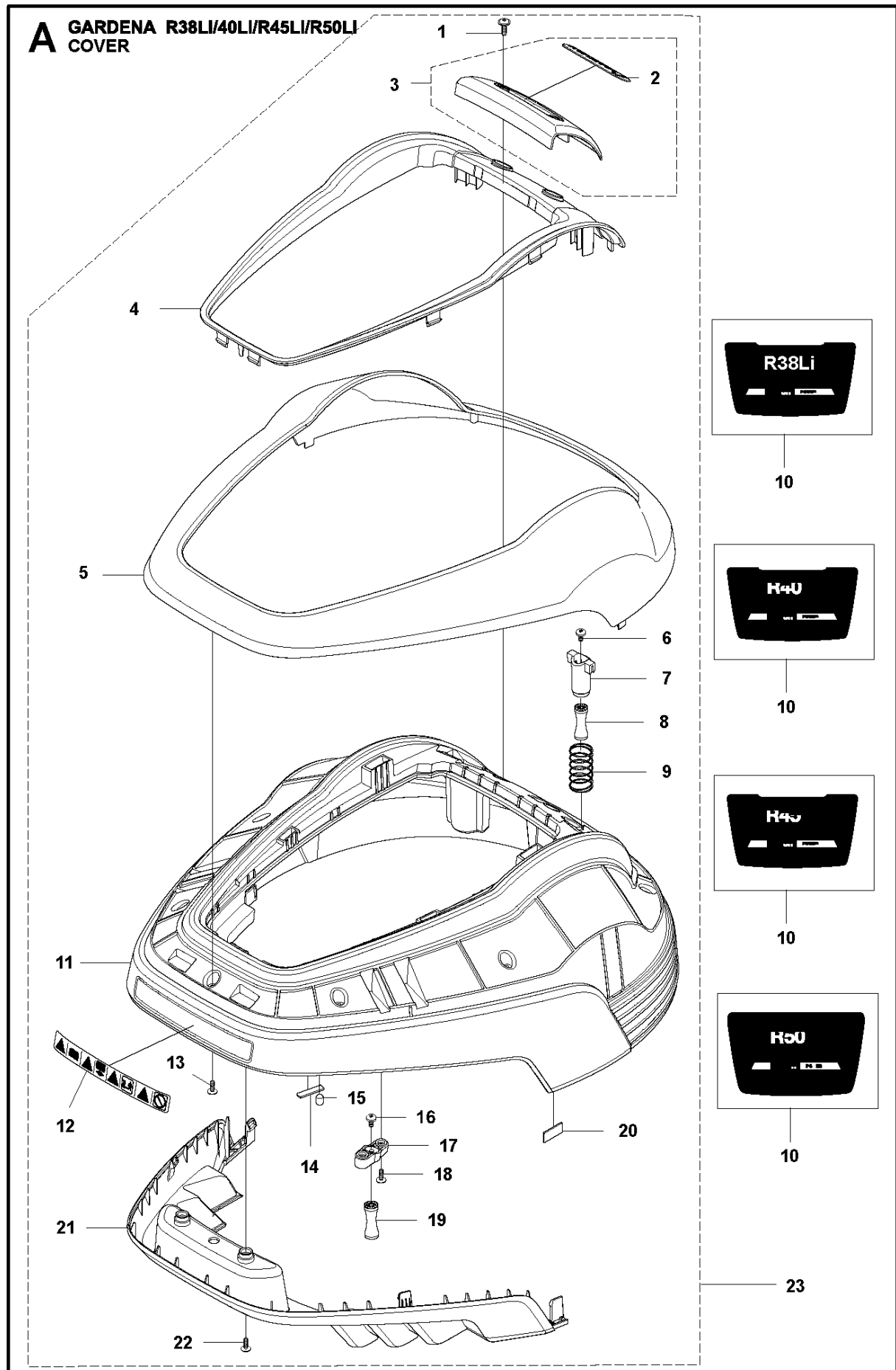

# SPARE PARTS LIST

ROBOTIC LAWN MOWERS

R38Li, 2016-03



Ref	Artikelnr	Beskrivning	Anmärkning	ANT	SATS
				AL	
1	575 54 33-14	SCREW	Grey (14 mm)	2	
2	510 31 03-01	LOGOTYP	Gardena Logotype	1	3
3	579 39 21-05	PLATE KIT	Logo, Plate KIT incl. Logo	1	
4	577 70 76-03	RAM		1	
5	577 70 73-03	KÅPA		1	
6	576 21 39-01	SKRUV ITXPANM		2	
7	574 46 90-02	FÄSTE	Lift Sensor	2	
8	574 46 91-02	DAMPER		2	
9	574 48 51-02	FJÄDER	Lift Sensor	2	
10	587 04 35-03	DEKAL	Decal, R38Li	1	
10	580 92 80-01	DEKAL	Decal, R40Li	1	
10	581 96 66-01	DEKAL	Decal, R45Li	1	
10	587 04 35-01	DEKAL	Decal, R50Li	1	
11	579 39 17-02	KIT		1	
12	586 35 97-01	DEKAL	Warning	1	11
13	575 54 33-14	SCREW	Grey (14 mm)	7	
14	576 03 01-01	PLATTA	Collision Sensor	1	11
15	576 18 33-01	MAGNET	Collision Sensor	1	11
16	576 21 39-01	SKRUV ITXPANM		2	
17	575 41 60-02	SUPPORT CLAMP		2	
18	575 54 33-14	SCREW	Grey (14 mm)	4	
19	574 46 91-02	DAMPER		2	
20	576 18 32-01	MAGNET	Lift Sensor	1	11
21	577 70 65-01	STÖTFÅNGARE	Rear	1	
22	575 54 33-14	SCREW	Grey (14 mm)	2	
23	577 95 53-08	BODY SYSTEM	excl. Model Decal	1	

**B** GARDENA R38LI/40LI/R45LI/R50LI  
CHASSIS UPPER

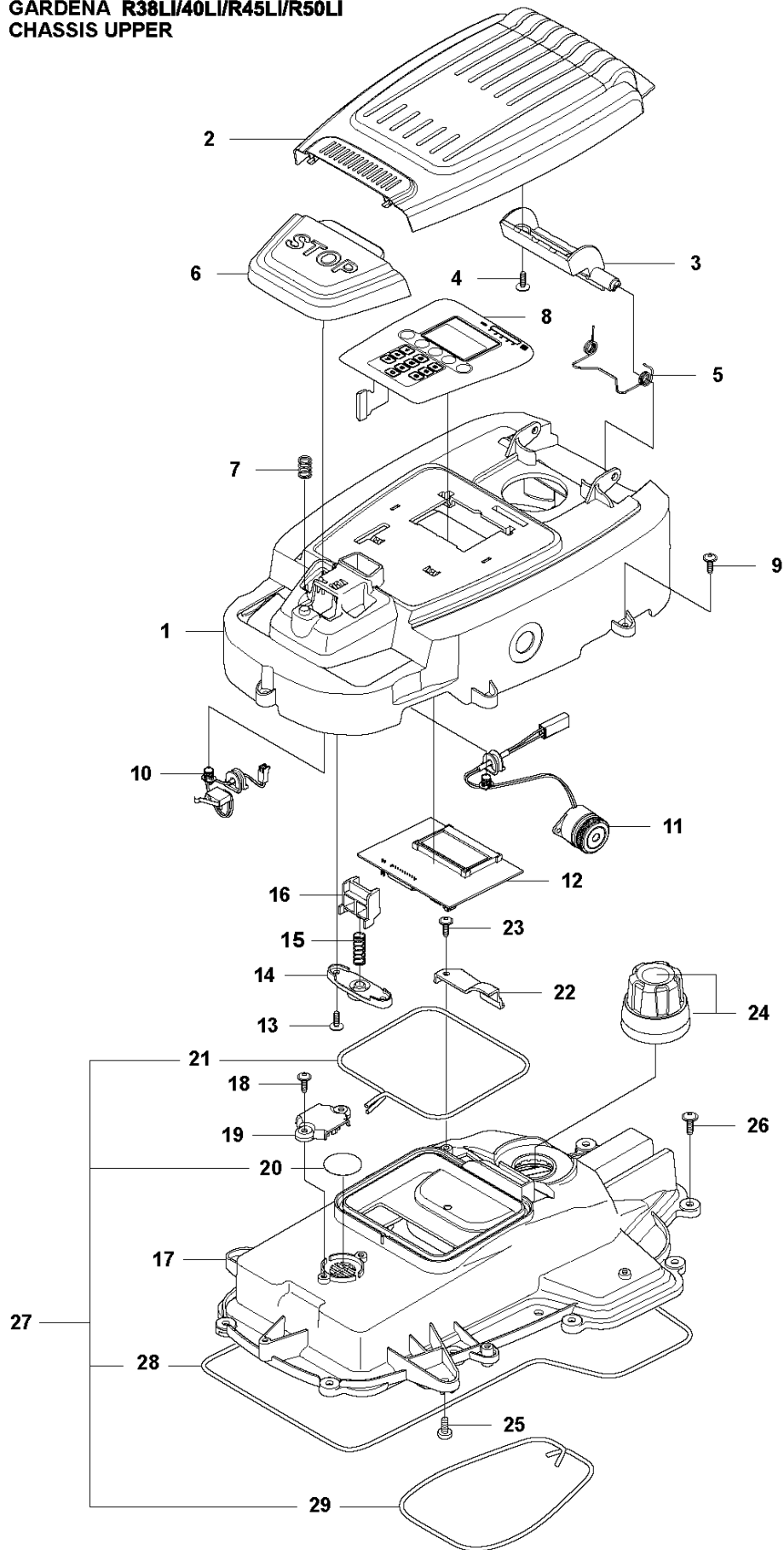

Ref	Artikelnr	Beskrivning	Anmärkning	ANT	SATS
				AL	
1	579 39 19-03	TÄCKLOCKSSATS	Display Cover KIT incl. Sealing & Keyboard	1	
2	577 70 72-03	KÅPA	Height Adjustment	1	
3	577 70 78-01	GÅNGJÄRN	Height Adjustment Lid	1	
4	575 54 33-14	SCREW	Grey (14 mm)	2	
5	578 44 52-01	FJÄDER	Height Adjustment Lid	1	
6	577 70 66-01	KNAPP	Stop Button	1	
7	574 48 70-01	FJÄDER	Stop Button	1	
8	586 94 56-01	TANGENTBORD		1	1
9	575 54 33-14	SCREW	Grey (14 mm)	5	
10	574 48 03-01	BRYTARE	Stop Button	1	
11	574 47 59-01	BUZZER	Display Cover	1	
12	588 44 19-01	KRETSKORT	Circuit Board	1	
13	575 54 33-14	SCREW	Grey (14 mm)	2	
14	575 41 58-01	FJÄDERHÅLLARE	Stop Button	1	
15	576 24 22-01	FJÄDER	Stop Button	1	
16	575 40 90-01	LÅS	Stop Button	1	
17	579 39 20-02	KIT	Chassis Upper KIT incl. Sealing & Air Filter	1	
18	575 54 33-14	SCREW	Grey (14 mm)	2	
19	576 69 70-01	KÅPA	Air Filter	1	
20	577 75 37-01	KIT	(10 pcs)	1	
21	574 87 47-04	TÄTNINGSLIST	(1 pcs, diam. 4 mm)	1	
22	576 05 39-01	KÅPA	Height Indicator	1	
23	575 54 33-14	SCREW	Grey (14 mm)	1	
24	579 39 22-01	KIT	incl. Knob & Sticker	1	
25	576 21 39-01	SKRUV ITXPANM		2	
26	574 45 01-01	SKRUV ITXPANT		10	
27	588 40 70-01	SEAL KIT	Seal KIT incl. Sealing Strip Chassis (1 pcs), Sealing Strip Short (2 pcs), Air Filter (1 pcs)	1	
28	574 87 47-03	TÄTNINGSLIST	(1 pcs, diam. 4 mm)	1	
29	574 87 47-04	TÄTNINGSLIST	(1 pcs, diam. 4 mm)	1	

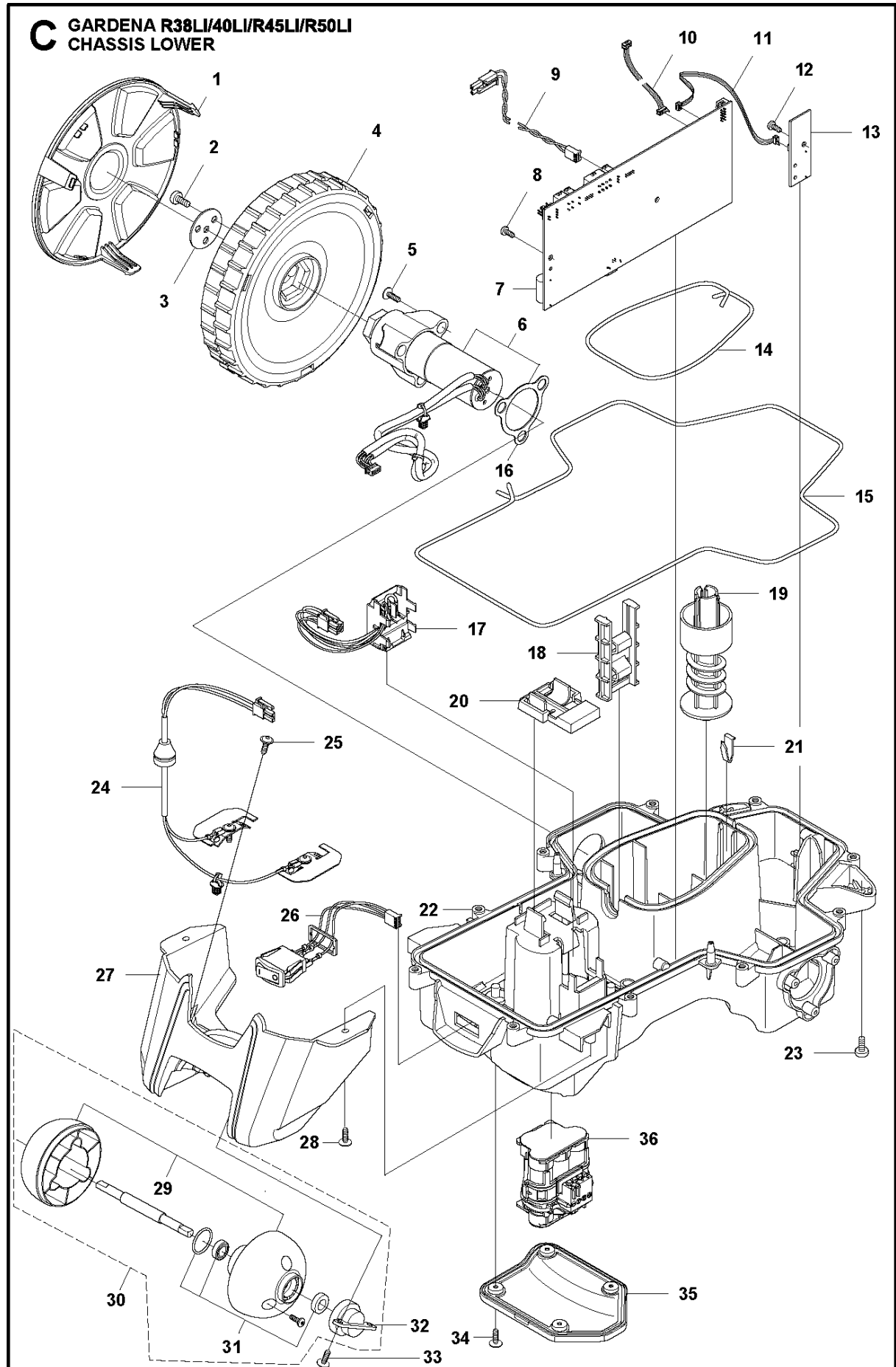

Ref	Artikelnr	Beskrivning	Anmärkning	ANT	SATS
				AL	
1	577 70 79-01	NAVKAPSEL	Drive Wheel	2	
2	576 21 39-02	SKRUV ITXPANM		6	
3	577 09 32-01	BRICKA	Drive Wheel	2	
4	574 46 51-04	HJUL	Drive Wheel	2	
5	575 54 33-14	SCREW	Grey (14 mm)	6	
6	577 83 99-04	WHEEL MOTOR ASSY	incl. Sealing	2	
7	588 62 88-03	KRETSKORT	(MCB)	1	
8	535 13 03-10	SKRUV ITXPANT	(10 mm)	2	
9	576 22 02-01	LOOM	Buzzer Extension	1	
10	588 83 27-01	KABLAGE KPL	Display	1	
11	588 90 12-01	KABLAGE KPL	Loop and Lift Sensor	1	
12	535 13 03-10	SKRUV ITXPANT	Screw (10 mm)	1	
13	588 57 21-01	KRETSKORT	PCB Sensor Board	1	
14	574 87 47-04	TÄTNINGSLIST	(1 pcs, diam. 4 mm)	1	
15	574 87 47-03	TÄTNINGSLIST	(1 pcs, diam. 4 mm)	1	
16	574 37 37-01	PACKNING	Motor Flange	2	6
17	574 47 98-01	LOOM	Li-Ion Battery	1	
18	574 50 19-01	STYRSKENA	Motor Bowl	2	
19	574 48 46-01	SCREW	Height Adjustment	1	
20	575 40 82-01	LÅS	Battery Plug	1	
21	577 10 32-01	LÅSFJÄDER	Locking	1	
22	577 84 62-02	CHASSI	incl. Sealing	1	
23	576 21 39-01	SKRUV ITXPANM		2	
24	588 95 09-01	KABLAGE KPL	Charge Plate	1	
25	575 52 95-02	SKRUV ITXPANTT	Grey (14 mm)	2	
26	579 70 87-01	KABLAGE KPL	Swith ON/OFF With Seal	1	
27	574 46 72-02	HUS	Rear Wheel	1	
28	575 54 33-14	SCREW	Grey (14 mm)	3	
29	583 85 39-02	BAKHJUL	KIT	1	30
30	578 27 51-03	BAKHJUL	KIT Complete	1	
31	578 27 52-01	BAKHJUL	Bearing (X2), Sealing (X2), O-Ring (X1)	1	30
32	577 71 50-01	LAGERHUS	Rear Wheel	2	30
33	575 54 33-14	SCREW	Grey (14 mm)	4	
34	574 45 01-01	SKRUV ITXPANT		4	
35	574 46 73-01	KÅPA	Battery	1	
36	574 47 68-01	BATTERI	Lithium 18 v	1	

**D** GARDENA R38LI/40LI/R45LI/R50LI  
BLADE MOTOR & CUTTING EQUIPMENT

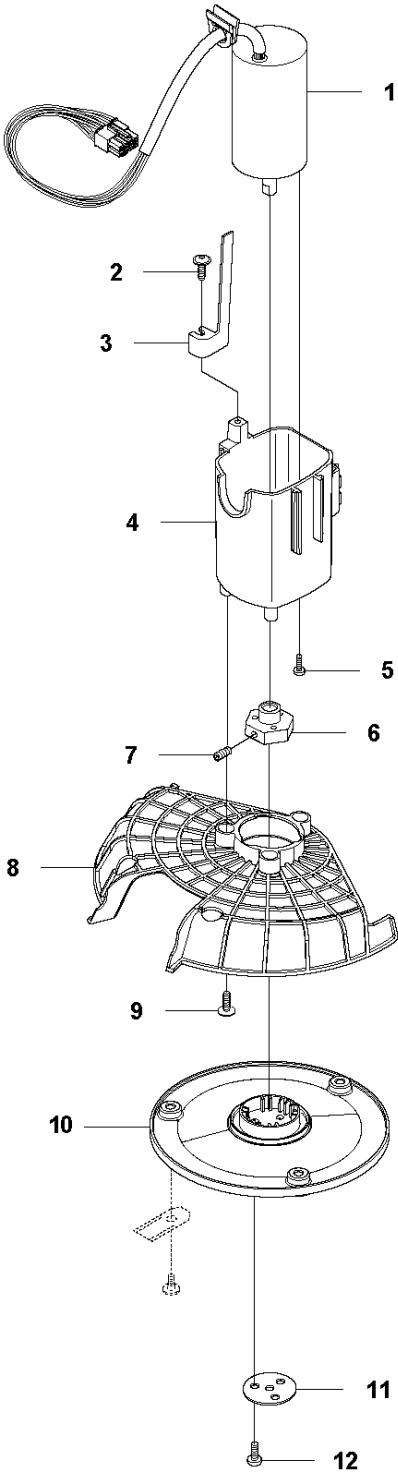



Ref	Artikelnr	Beskrivning	Anmärkning	ANT SATS AL
1	584 98 93-02	MOTOR		1
2	575 54 33-14	SCREW	Grey (14 mm)	1
3	574 50 35-01	HEIGHT INDICATOR	Height Indicator	1
4	581 02 03-01	MOTORHUS		1
5	576 21 38-01	SKRUV ITXPANM	M4x12	3
6	574 37 35-01	NAV	Cutting Motor	1
7	576 21 35-01	SKRUV IHSETM	Stop	1
8	577 85 02-05	SKYDD	Cutting Disc	1
9	575 54 33-14	SCREW	Grey (14 mm)	3
10	574 48 71-01	KNIVDISK		1
11	577 09 32-01	BRICKA		1
12	576 21 38-01	SKRUV ITXPANM		3

**E** GARDENA R38LI/40LI/R45LI/R50LI  
CHARGING STATION

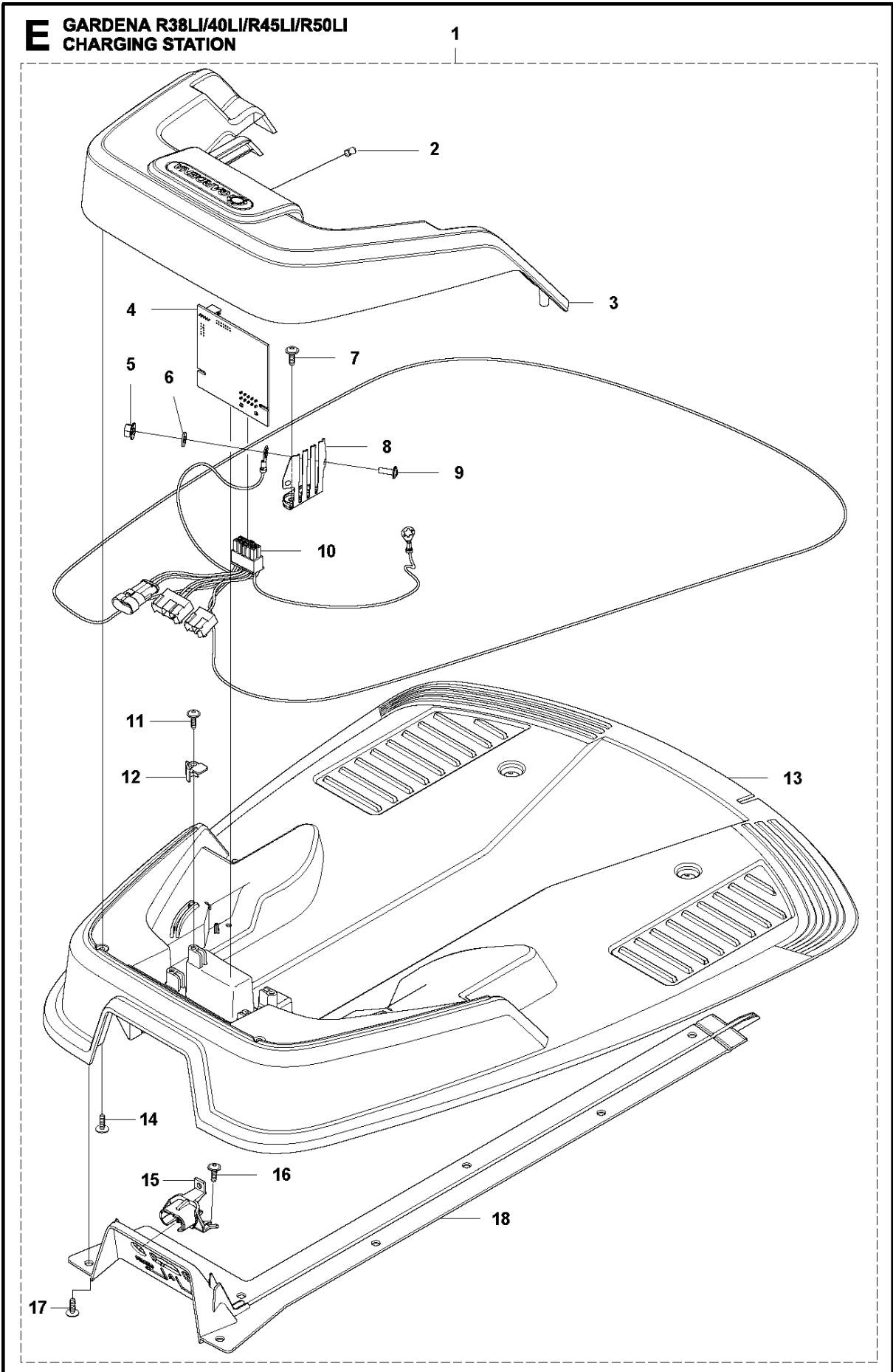

Ref	Artikelnr	Beskrivning	Anmärkning	ANT	SATS
1	577 97 23-09	LADDSTATION		1	AL
2	535 12 87-02	DIODLINS		1	1
3	584 61 83-01	LADDSTATION	Charging Station	1	1
4	588 88 25-01	KRETSKORT	Charging Station	1	1
5	588 22 21-01	HEXAGON NUT FLANGE		2	1
6	535 08 74-01	BRICKA		2	1
7	575 54 33-14	SCREW	Grey (14 mm)	2	1
8	587 12 51-01	KONTAKT	Charging Station	2	1
9	588 22 22-01	SKRUV ITXPANM		2	1
10	588 49 03-02	KABLAGE KPL	Charging Station	1	1
11	575 54 33-14	SCREW	Grey (14 mm)	2	1
12	535 12 79-01	FÄSTE		2	1
13	581 55 19-02	LADDSTATION	Charging Station	1	1
14	575 54 33-14	SCREW	Grey (14 mm)	4	1
15	587 87 85-01	FÄSTE		1	1
16	575 54 33-14	SCREW	Grey (14 mm)	2	1
17	575 54 33-14	SCREW	Grey (14 mm)	4	1
18	587 87 84-01	STYRNING	Charging Station	1	1

**F** GARDENA R38Li/40Li/R45Li/R50Li  
INSTALLATION ACCESSORIES

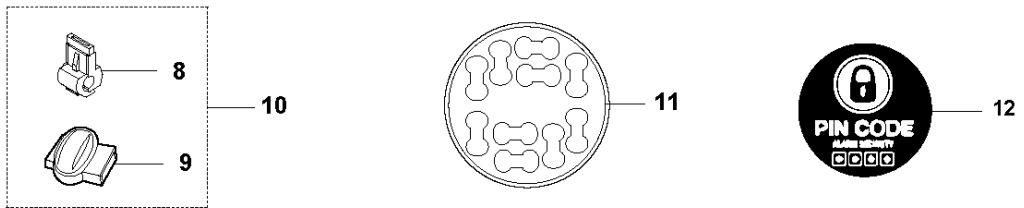
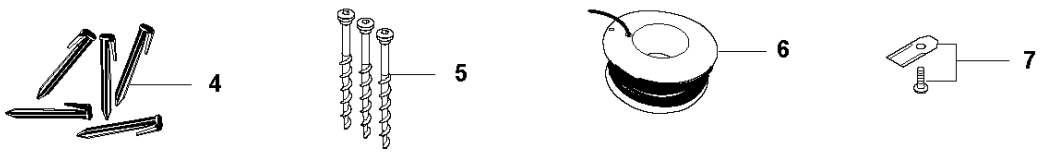
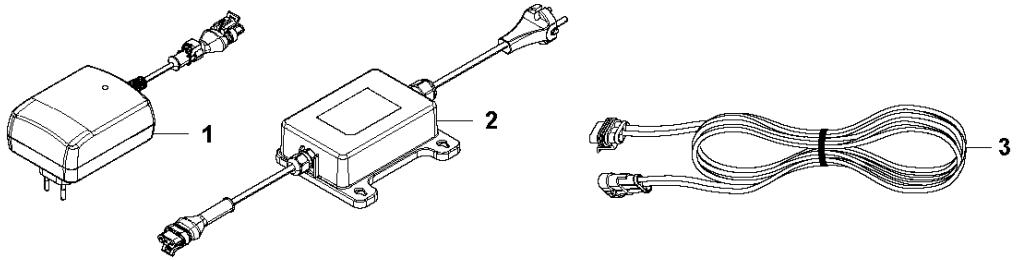

Ref	Artikelnr	Beskrivning	Anmärkning	ANT	SATS
				AL	
1	584 86 25-01	DRIVENHET	EU	1	
2	584 86 26-02	DRIVENHET	UK	1	
2	584 86 26-03	DRIVENHET	CH	1	
2	584 86 26-04	DRIVENHET	CA	1	
2	584 86 26-05	DRIVENHET	AU-NZ	1	
3	579 82 51-01	KABLAGE KPL	(20 m)	1	
3	579 82 51-02	KABLAGE KPL	(10 m)	1	
3	579 82 51-03	KABLAGE KPL	(3 m)	1	
4	966 80 98-01	KLAMMER	(100 pcs), Gardena Blister Pack	1	
4	Gardena409020	TBD	(100 pcs), Gardena Blister Pack	1	
5	575 23 86-02	SCREW KIT	(3 pcs) incl. Allen Key	1	
6	966 80 96-01	VAJER	(150 m), Gardena Blister Pack	1	
6	Gardena408820	TBD	(150 m), Gardena Blister Pack	1	
7	966 80 95-01	KNIV	(9 pcs), Gardena Blister Pack	1	
7	Gardena408720	TBD	(9 pcs), Gardena Blister Pack	1	
7	577 60 65-04	BLADE SET	45 pcs	1	
7	577 60 66-03	BLADE SET	300 pcs	1	
8	535 12 90-01	KOPPLING	(1pcs)	1	10
9	501 98 02-01	KOPPLING	(1pcs)	1	10
9	501 98 02-02	KOPPLING	(50pcs)	1	
10	966 80 97-01	KOPPLING	2 Connectors+6 Couplers, Gardena Blister Pack	1	
10	Gardena408920	TBD	2 Connectors+6 Couplers, Gardena Blister Pack	1	
10	579 04 81-01	TILLBEHÖRSPÅSE	5 Connectors+5 Couplers	1	
11	586 27 79-01	ETIKETT	Cable Markers (10 pcs)	1	
12	502 40 53-01	DEKAL	Anti-Theft	1	
13	578 90 91-05	DVD		1	
14	115 78 71-01	BRUKSANVISNING	Swedish	1	
14	115 78 71-06	BRUKSANVISNING	Danish	1	
14	115 78 71-11	BRUKSANVISNING	Finnish	1	
14	115 78 71-21	BRUKSANVISNING	Norwegian	1	
14	115 78 71-26	BRUKSANVISNING	English	1	
14	115 78 71-31	BRUKSANVISNING	French	1	
14	115 78 71-36	BRUKSANVISNING	Dutch	1	
14	115 78 71-41	BRUKSANVISNING	Italian	1	
14	115 78 71-46	BRUKSANVISNING	Spanish	1	
14	115 78 71-51	BRUKSANVISNING	German	1	
14	115 78 71-58	BRUKSANVISNING	Hungarian	1	
14	115 78 71-59	BRUKSANVISNING	Portuguese	1	
14	115 78 71-61	BRUKSANVISNING	Polish	1	
14	115 78 71-68	BRUKSANVISNING	Slovakian	1	
14	115 78 71-84	BRUKSANVISNING	Slovenian	1	
14	115 78 71-90	BRUKSANVISNING	Czech	1	
15	115 78 72-01	QUICK GUIDE	Swedish	1	
15	115 78 72-06	QUICK GUIDE	Danish	1	
15	115 78 72-11	QUICK GUIDE	Finnish	1	
15	115 78 72-21	QUICK GUIDE	Norwegian	1	
15	115 78 72-26	QUICK GUIDE	English	1	
15	115 78 72-31	QUICK GUIDE	French	1	
15	115 78 72-36	QUICK GUIDE	Dutch	1	
15	115 78 72-41	QUICK GUIDE	Italian	1	
15	115 78 72-46	QUICK GUIDE	Spanish	1	
15	115 78 72-51	QUICK GUIDE	German	1	
15	115 78 72-58	QUICK GUIDE	Hungarian	1	
15	115 78 72-59	QUICK GUIDE	Portuguese	1	
15	115 78 72-61	QUICK GUIDE	Polish	1	
15	115 78 72-68	QUICK GUIDE	Slovakian	1	
15	115 78 72-84	QUICK GUIDE	Slovenian	1	
15	115 78 72-90	QUICK GUIDE	Czech	1	

**G** GARDENA R38Li/40Li/R45Li/R50Li  
ACCESSORIES

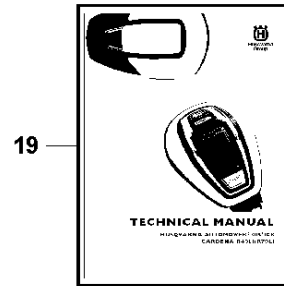
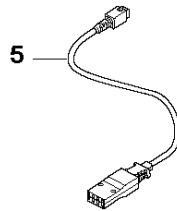
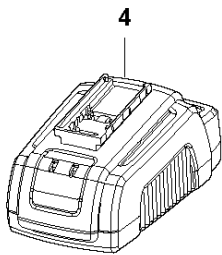
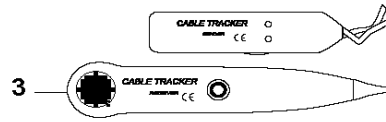
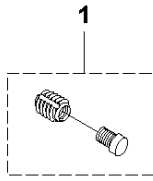

18

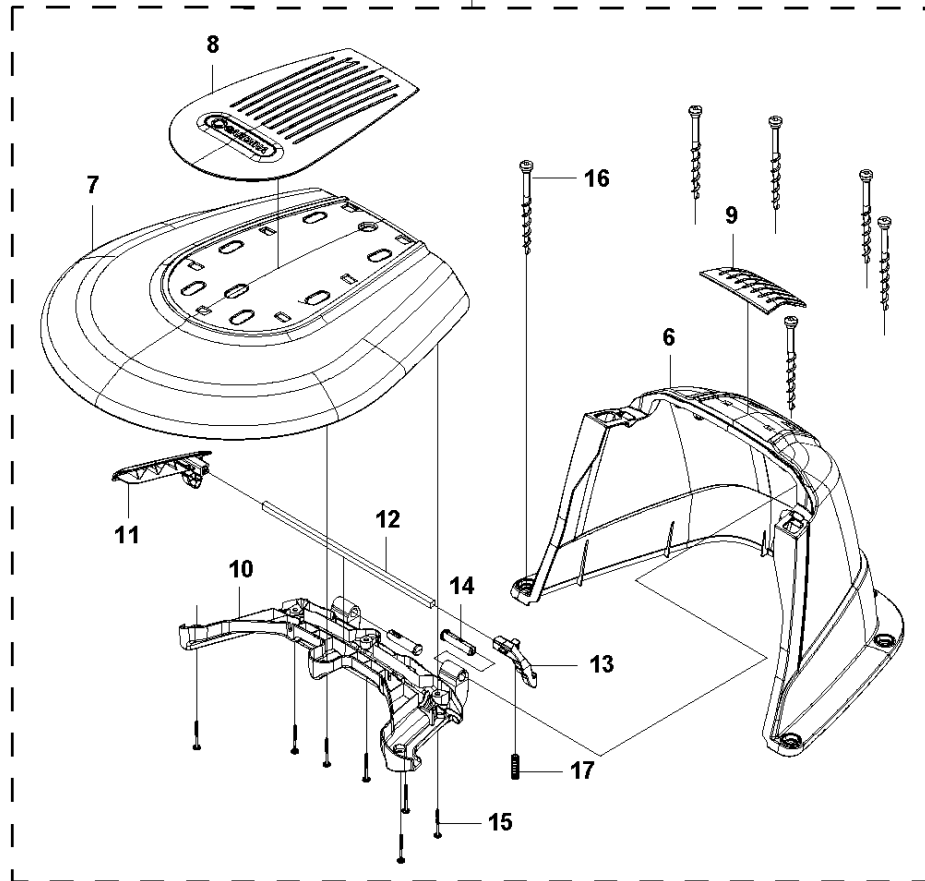

Ref	Artikelnr	Beskrivning	Anmärkning	ANT	SATS
				AL	
1	581 16 57-01	GÄNGINSATS	(4 pcs)	1	
2	580 68 95-02	DEKAL	1pcs	1	
3	577 60 68-01	TESTUTRUSTNING	Interruption	1	
4	588 40 84-01	LADDARE	Quick Charger with Battery Test	1	
5	588 20 26-01	KABLAGE KPL	Cable Quick Charger	1	
6	587 91 63-01	TÄCKLOCKSSATS	Base	1	18
7	587 91 64-01	TÄCKLOCKSSATS	Lid	1	18
8	586 69 44-01	KÅPA	Front Insert	1	18
9	586 69 46-01	KÅPA	Rear Insert	1	18
10	586 69 42-01	BALK	Hinge	1	18
11	586 69 47-01	HANDTAG	Left	1	18
12	585 32 41-02	STÅNG		1	18
13	586 69 48-01	SPÄRRHAKE	Right	1	18
14	585 34 15-01	GÅNGJÄRNSPINNE		2	18
15	575 54 33-14	SCREW		8	18
16	575 23 86-01	SCREW KIT		1	18
17	580 51 14-01	FJÄDER		1	18
18	586 80 17-01	HUS		1	
19	115 44 50-01	VERKSTADSHANDBOK	Swedish	1	
19	115 44 50-06	VERKSTADSHANDBOK	Danish	1	
19	115 44 50-11	VERKSTADSHANDBOK	Finnish	1	
19	115 44 50-21	VERKSTADSHANDBOK	Norwegian	1	
19	115 44 50-26	VERKSTADSHANDBOK	English	1	
19	115 44 50-31	VERKSTADSHANDBOK	French	1	
19	115 44 50-36	VERKSTADSHANDBOK	Dutch	1	
19	115 44 50-41	VERKSTADSHANDBOK	Italian	1	
19	115 44 50-46	VERKSTADSHANDBOK	Spanish	1	
19	115 44 50-51	VERKSTADSHANDBOK	German	1	
19	115 44 50-56	VERKSTADSHANDBOK	Russian	1	
19	115 44 50-58	VERKSTADSHANDBOK	Hungarian	1	
19	115 44 50-61	VERKSTADSHANDBOK	Polish	1	
19	115 44 50-62	VERKSTADSHANDBOK	Romanian	1	
19	115 44 50-63	VERKSTADSHANDBOK	Estonian	1	
19	115 44 50-64	VERKSTADSHANDBOK	Latvian	1	
19	115 44 50-65	VERKSTADSHANDBOK	Lithuanian	1	
19	115 44 50-71	VERKSTADSHANDBOK	Greek	1	
19	115 44 50-76	VERKSTADSHANDBOK	Turkish	1	
19	115 44 50-81	VERKSTADSHANDBOK	Croatian	1	
19	115 44 50-90	VERKSTADSHANDBOK	Czech	1	